

1 2 3 4 5 6 7 8

A
B
C
D
E
F

A
B
C
D
E
F

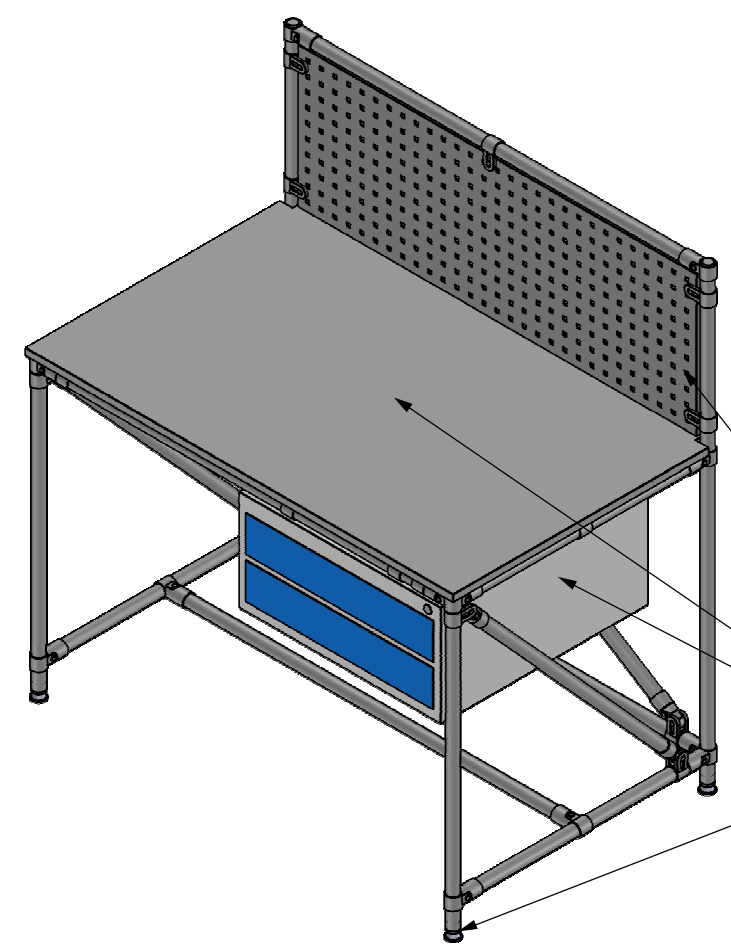
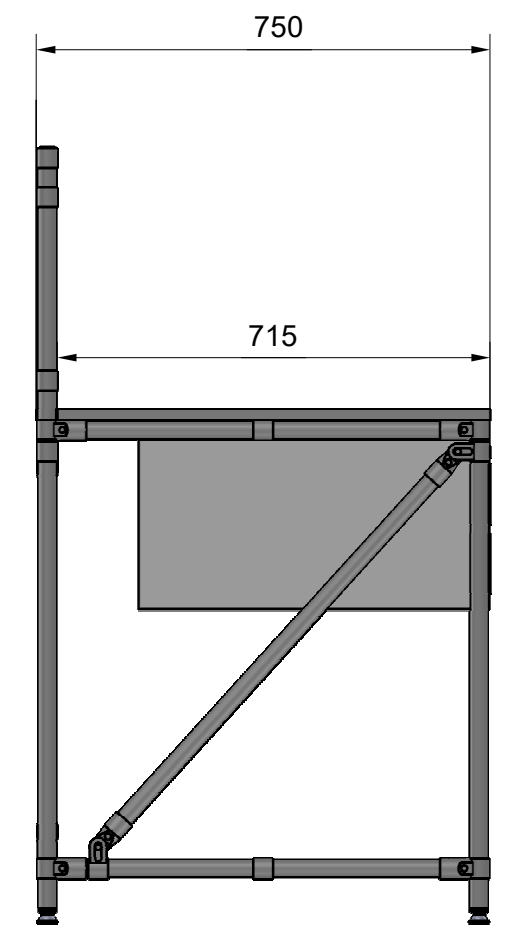
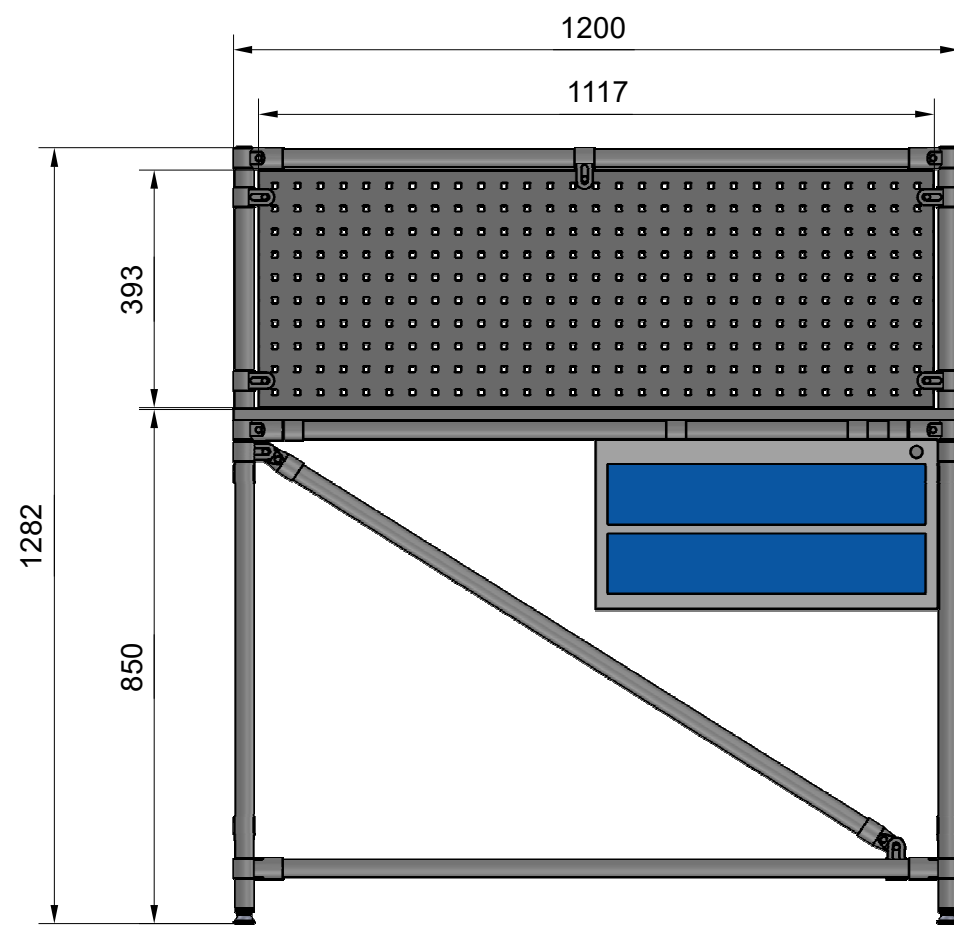

- Perfopanel 1117x393mm
- Dřevotřísková deska oboustranně laminovaná v dekoru 112 Kamenná šedá
- Stolový kontejner XB20-2TG
- 4x stavitelné nožičky

Workshop accuracies for general tolerances - Tolerances for length and angle dimensions; DIN ISO 2768-1-v
-Machining details and finish classification to DIN ISO 1302

E	Total load capacity*: (Celková nosnost:*) 100 kg		Load capacity - floor*: (nosnost na patro:*)		
	Scale	A3	Drawn Kempný	Checked	Dat. 08.04.2024
	Title Enprag				Sheet 1 of 1
	Title Dílenský stůl s perfopanelem				Rev. A00
					Doc.Nr 240408314

This document is the sole property of Enprag s.r.o. and may not be copied, duplicated, used or given to third parties without the written permission from Enprag s.r.o. Misuse is subject to penalties and will be legally pursued

Tolerances for shape and condition:
- DIN ISO 2768-2-K
Tolerancing:
- DIN 7167

1 2 3 4 5 6 7 8